



1860 Eastman Ave. Unit 109
Ventura, CA 93003
(866) 482-7930
www.chargetek.com



7582 Las Vegas Blvd. South #219
Las Vegas, NV 89123
(702) 576-1717
www.potentialdifference.com

WARP CHARGE™ Development Tool Users Manual

True rapid charging technology

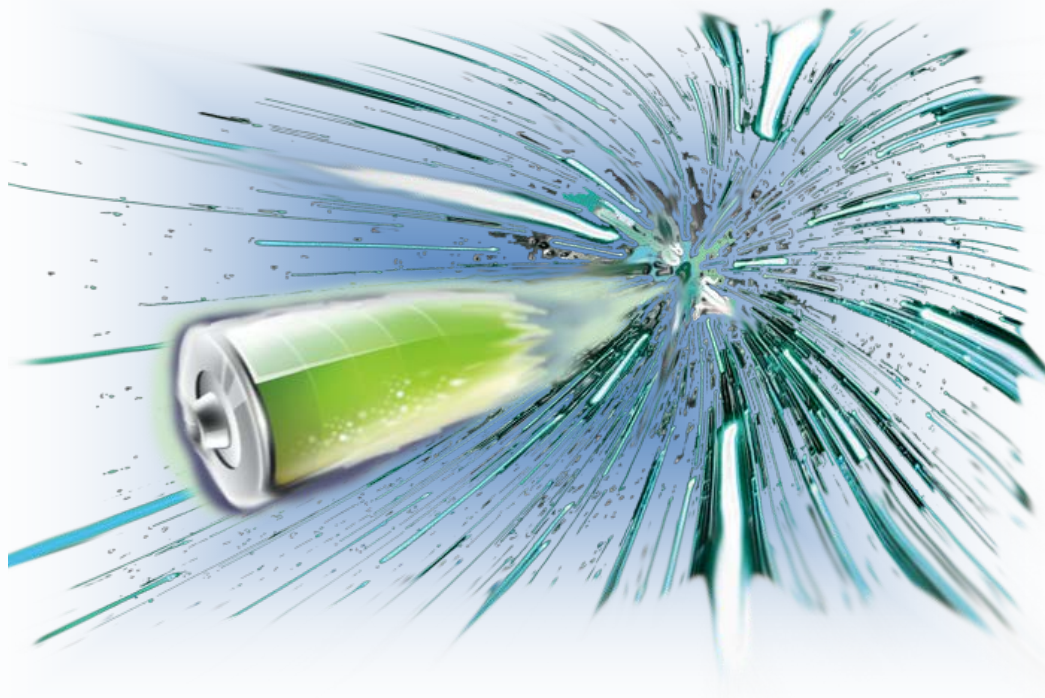

1.0 Introduction

Chargetek, in collaboration with PDI, has developed a true rapid charging technology that can safely return a 56% charge in 25 minutes. This technology is applicable for a broad range of chemistries and capacities.

- Does not overheat or overvoltage the battery
- Proprietary software can be customized per application
- Warp Charge™ is compatible with the most common battery chemistries
- Real time temperature, voltage and current control ensures safe and optimal charging
- Charging systems can be configured from watts to kilowatts quickly and economically

Warp Charge™ is a reasonable tradeoff between charge speed and battery life!

The development tool depicted below was designed to demonstrate the Warp Charge™ algorithm and also to provide a means for testing and refining the algorithm for various battery capacities and chemistries. The battery chosen to demonstrate Warp Charge™ is the Panasonic 18650 lithium cell since it is one of the most widespread cells used worldwide. The cell data sheet is on the last page of this manual.

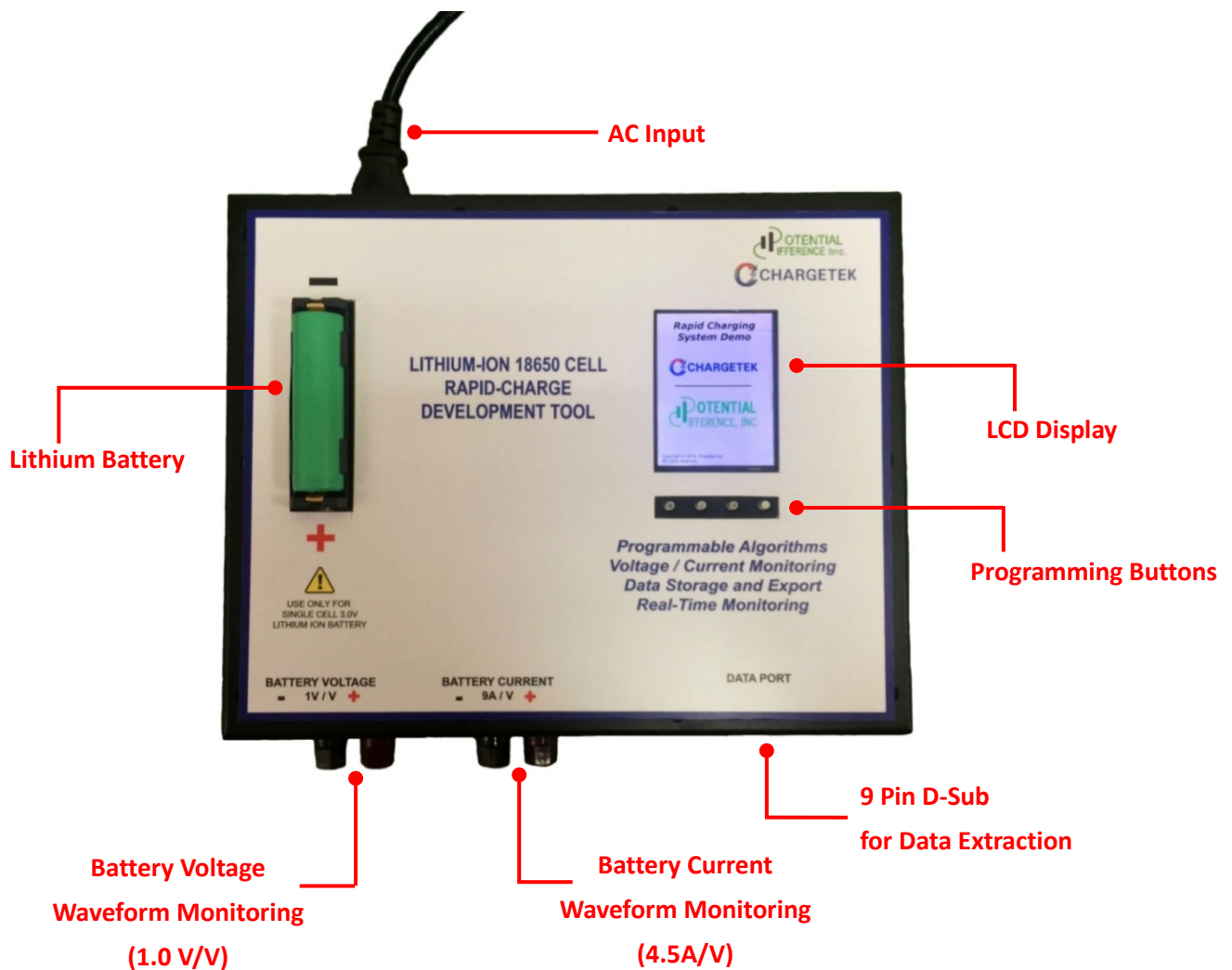

Figure 1
Warp Charge™ Development Tool

2.0 The Warp Charge™ Algorithm

There are intrinsic limitations characteristic of every battery: maximum voltage and temperature and the amplitude of the charging current. Exceeding any parameter can cause undercharging, overcharging, overheating or physical degradation. The consequence of rapid charging at high current is:

Electrochemical polarization: an imbalance of ions and a difference in electrochemical reaction speed which reduces charge acceptance and causes excessive battery temperature

Concentration polarization: the battery solution (electrolyte) has a higher concentration at one electrode than the other which causes excessive voltage that damages the battery. The W technique eliminates these obstacles to rapid charging.

2.1 Two Variants of Warp Charging

The following is a brief explanation of our charge algorithm. A simple graph below depicts the critical parameters. There are two simple variants of the Warp Charge™ algorithm are described below. The rest period is shifted to occur immediately before or following the positive charge pulse. This variation has shown some advantages in some particular battery chemistries and capacities.

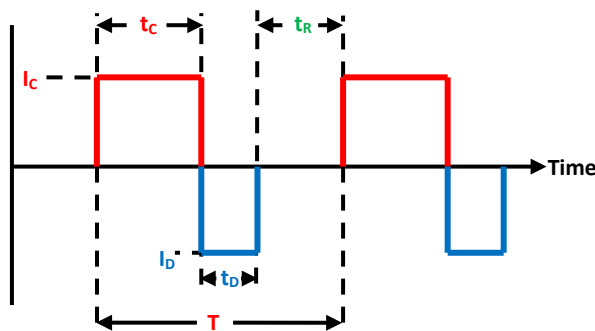

Figure 2
Charge before discharge

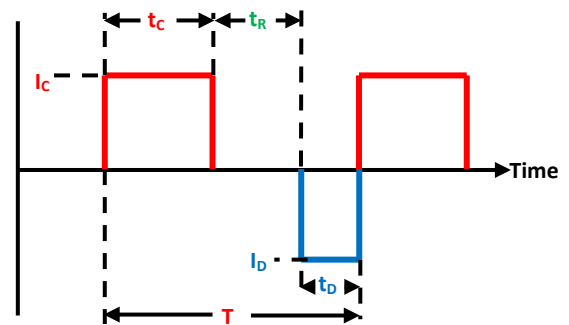

Figure 3
Discharge before charge

The Warp Charge™ technique is comprised of following fundamental components:

- **Charge current pulse:** The amplitude (I_c) and duration (t_c) of this current are depicted in red. A charge current of three to four times the amp hour rating of the battery is typically employed.
- **Discharge current pulse:** The amplitude (I_d) and duration (t_d) of this current are depicted in blue. The magnitude of this current is related to the magnitude of the charge current. The discharge current pulse is applied to the battery to negate the effects of electrolyte stratification and other second order effects resulting from the high amplitude charging current.
- **Rest time:** The battery current is zero and some cooling and settling of the electrolyte occurs (t_r).
- **Period:** The time duration of one Warp Charge™ waveform, (T)

2.2 Real Time Warp Charge™ Waveforms

Figures 4 and 5 below depict the configuration screens for two of the warp charge variants.

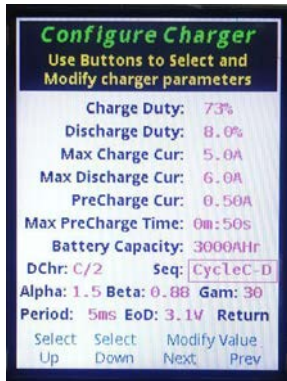

Figure 4

Charge before discharge (see Fig 2)

Note Setting for
Sequence (SEQ)

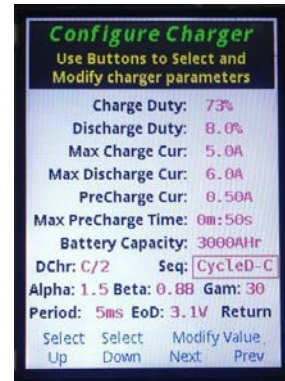

Figure 5

Discharge before charge (see Fig. 3)

Figures 6 and 7 below depict the real time waveforms of warp charging (discharge before charge).

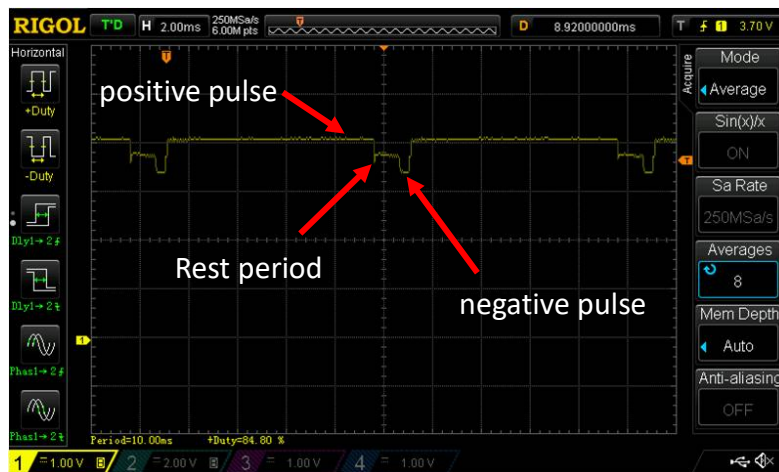

Figure 6

Battery Voltage during Warp Charge™
Vertical resolution = 1.0V/div

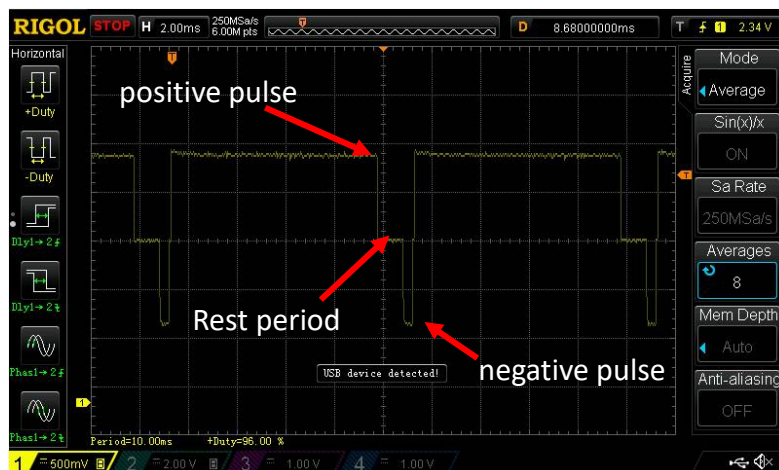

Figure 7

Battery Current during Warp Charge™
Vertical resolution = 4.0A/div

3.0 Configuration Screen: Definition of menu buttons

The following parameters can be modified to select various Warp Charge™ profiles:

- **Charge Duty:**

The duty cycle of the positive charging current, t_c/T

- **Discharge Duty:**

The duty cycle of the negative or discharge current, t_d/T

- **Max Charge Cur:**

The amplitude of the peak charging current, I_c . This will vary during the charging cycle.

- **Max Discharge Cur:**

The peak discharging current and varies during the charging cycle.

- **PreCharge Cur:**

If required, a precharge current is applied to obtain a minimum of 3.1V/cell before warp charging.

- **Max PreCharge Time:**

A time limit on the precharge current duration, used to determine if a battery is damaged.

- **Battery Capacity:**

The battery capacity in milliamp hours.

- **DChr:**

The discharge current amplitude during a controlled discharge to measure battery capacity.

- **Seq:**

Several charging sequences are programmable.

- **Alpha, Beta, Gamma:**

Mathematical variables that vary the charging algorithm.

- **Period:**

The length of time, T , of the Warp Charge™ waveform.

- **EoD:**

End of discharge battery voltage is the voltage at which a discharge cycle is terminated.

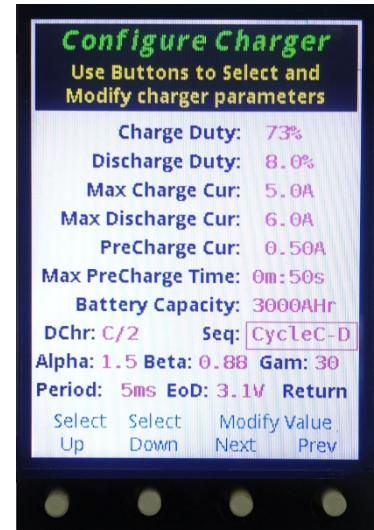

Figure 8
Configuration Menu

4.0 Charge Cycle Monitoring

During a charge cycle, the following parameters can be monitored in real time. This data is also available from the data port when the charge is completed. The data is recorded once per second. Using an oscilloscope, the current and voltage waveforms can be monitored from the two banana jack outputs as shown in Figures 6 and 7 above.

- **Bat_V**:battery voltage.
- **Dchrgi**:actual peak discharge pulse current.
- **Chrg i**:actual peak charge pulse current.
- **deg C** : battey temperature in Celcius.



Figure 9
Warp Charging Screen

- **ChrgDuty**:See charge duty above, tc/T
- **DchrgDuty**:See discharge duty above, td/T
- **Max BatV**:Maximum allowable battery voltage during a charging cycle.
- **Chrg I_SP**:Maximum allowable peak charging current, I_c
- **Dchrg I_SP**:Maximum allowable peak discharging current, I_d
- **Cell Cap**:The battery capacity in milliamp hours.

5.0 Capacity Measurement

The lithium battery cannot be completely discharged or its lifetime will be severely curtailed. A minimum capacity of 15% must be maintained and this effectively becomes the “zero” point of the available charge. The effectiveness of the charger is determined by measuring the amount of charge returned at the end of the charging cycle. The capacity resulting from warp charging is measured very accurately as follows:

1. The capacity determination is measured using the same minimum capacity (15%) for each cycle and is designated as “End of Discharge” or EOD.
2. The returned capacity (the true merit of the charger) is accurately measured at the end of each warp charging cycle using a constant current discharge as described section 6.0 below.
3. Using the technique, the returned capacity is independent of the minimum and total capacity

For example, if the initial charge is 15% and the returned charge is 50%, then the total capacity of the battery is 65%. If the initial charge is 20% and the returned charge is 50%, then the total capacity of the battery is 70%. Using this method the charge in the battery at the beginning of the cycle does not affect the measurement proving the safe minimum is maintained. We have estimated this to correlate to an EOD voltage of 3.1V, or 15% of capacity. Another EOD voltage could be chosen with no change in results since we are measuring the difference in charge and not the total charge.

$C_{MIN} = 15\% = 450\text{mAH} / \text{EOD} = 3.1$

$C_{MIN} = 20\% = 600\text{mAH} / \text{EOD} = 3.2$

$C_{RTN} = 50\% = 1500\text{mAH}$

$C_{RTN} = 50\% = 1500\text{mAH}$

$C_{TOTAL} = C_{MIN} + C_{RTN} = 65\% = 1950\text{mAH}$

$C_{TOTAL} = C_{MIN} + C_{RTN} = 70\% = 2100\text{mAH}$

$C_{BAT} = \text{Capacity of Battery} = 3000\text{mAH} = 100\%$

$C_{BAT} = \text{Capacity of Battery} = 3000\text{mAH} = 100\%$

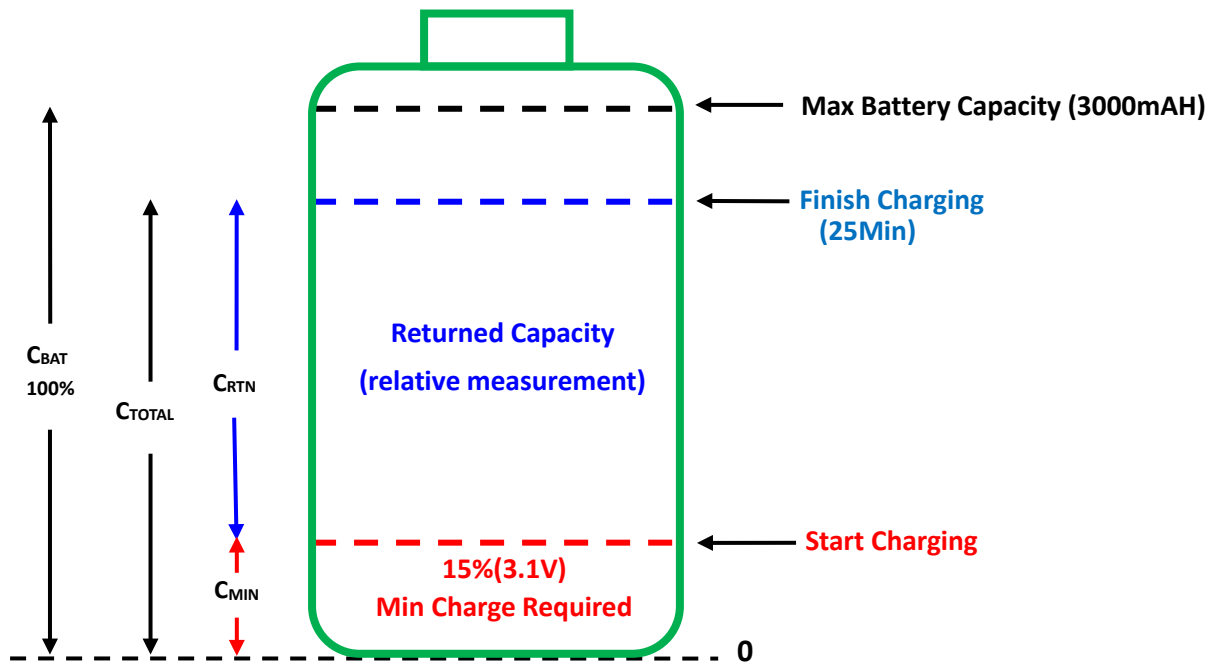

Figure 10
Capacity calculation method

6.0 Discharge Cycle

The capacity returned during the charge is measured by applying a constant current load to the battery and determining the amount of charge returned. The true merit of the charger is the amount of returned charge in a given time (t_{EOD}) without effecting battery life as described previously. The constant current discharge with a fixed end of discharge voltage (3.1V) is a very accurate way of determining returned capacity. A very simple calculation is used to determine the returned capacity:

$I_{DIS} * \text{discharge time} = \text{Capacity}$
 $(A) * (\text{Hours}) = A \text{ Hours}$
Example: Constant Current = 1.5A
Discharge time= 1.5 hours
Capacity = 1.5 amps * 1.5 hours = 2.25 amp hours

- **Bat_V:**Battery voltage during the discharge cycle
- **Dchrg I_SP:**Constant discharging current
- **Cell Cap:**The battery capacity in milliamp hours



Figure 11
Constant Current Discharge

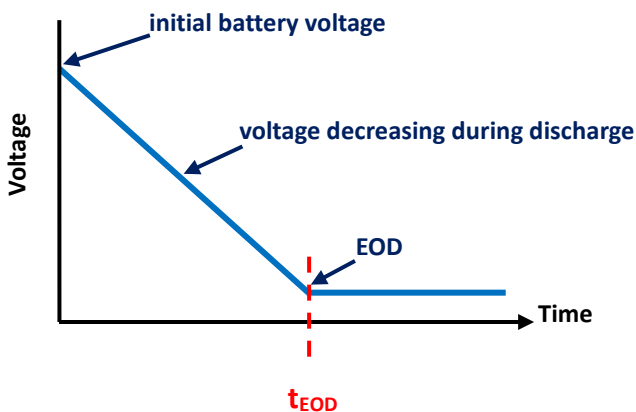

Figure 12
Voltage during Discharge

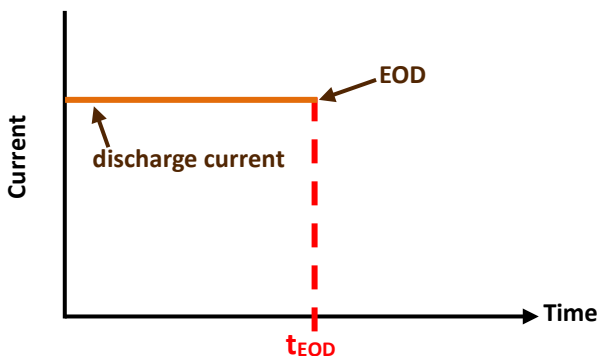

Figure 13
Constant 1.5 Amp Discharge

7.0 Conventional Charging

In order to calculate battery life time at the end of a life test, ie., hundreds of charge/discharge cycles, a conventional charge is employed. This is the method the battery manufacturers use to specify battery capacity so a direct correlation can be made between number of cycles and battery life. A single conventional charge of a cyclic conventional charge can be programmed.

The charge algorithm for a conventional charge is depicted in Figure 16 below. A constant charge current is applied until the battery voltage rises to 4.2V. At this point, the battery voltage is maintained at 4.2V and the charge current decreases. The charge cycle is terminated when the charging current reduces to 60mA. The charger is turned off and no additional charge is supplied to the battery.



Figure 14
Conventional Single Cycle

Note Setting for Sequence (SEQ)

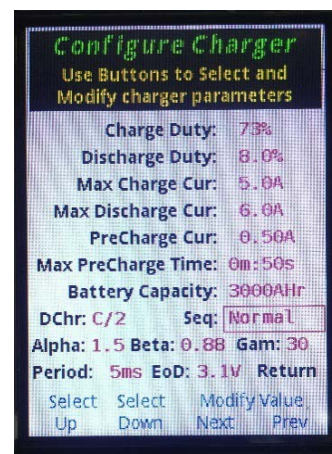

Figure 15
Conventional Multi Cycle

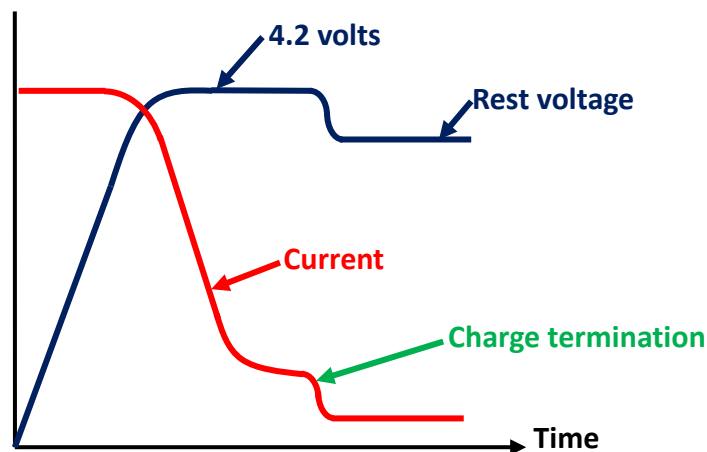

Figure 16
Conventional Charge algorithm

8.0 WARP CHARGE™ Test Results

The following is a summary of the most recent warp charge cycle test method and results.

Group 1: Cell 1 (140 cycles) and Cell 2(180 cycles) : End of Discharge point is 3.1 volts

Group 2: Cell 3 (140 cycles) and Cell 4 (180 cycles): End of Discharge point is 3.2 volts

Column Definitions:

- **1. End of discharge:** the cell voltage at which the discharge is terminated
- **2. Returned charge:** the resultant capacity of the cell due to the charge cycle
- **3. Total Charge:** the total capacity in the cell which is the sum of initial charge and returned charge
- **4. # Cycles:** the number of repetitive and identical charge cycles conducted in the cycle testing
- **5.Max temp:** the maximum cell temperature during charge
- **6.Max voltage:** the maximum cell voltage during charge
- **7. Capacity:** the cell capacity at the completion of the cycle testing
- **8. Capacity of new cell:** the capacity of a new cell before cycle testing
- **9. Capacity corrected:** the capacity corrected for normal degradation of a conventional charge
- **10. Accelerated aging:** the capacity decrease from a warp charge compared to a conventional charge

Panasonic: NCR18650

New Cell capacity = 2900mAH

WARP CHARGE™ time: 25 min

Ambient temp = 18C - 22C

Cell Capacity @ 140 cycles = 2500mAH

Cell Capacity @ 180 cycles = 2400mAH

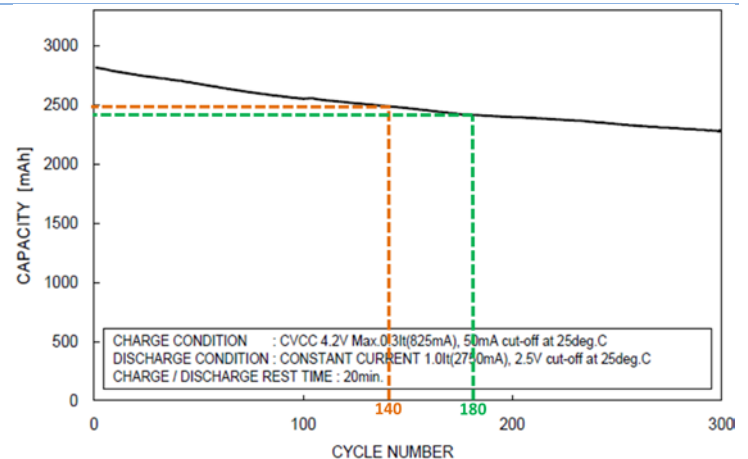

	1	2	3	4	5	6	7	8	9	10
	EOD / Initial charge	returned capacity	total charge	# cycles	max temp(C)	max voltage	capacity (AH)	% capacity of new cell	% capacity corrected	accelerated aging
Cell 1	3.10/15%	48%	63%	140	39	4.22	2.16	74%	86%	14%
Cell 2	3.10/15%	47%	62%	180	40	4.22	1.85	64%	77%	23%
Cell 3	3.20/21%	49%	70%	140	41	4.22	2.39	82%	96%	4%
Cell 4	3.20/21%	48%	69%	180	39	4.22	2.27	78%	95%	5%

Observations:

Approximately 50% of charge in 25 minutes is returned with small to moderate effect on battery life.

The higher EOD cutoff point (3.2V) resulted in a significantly longer cycle life.

The maximum cell temperature and voltage were well within manufacture defined limits

The accelerated cell degradation was less than 6% over a conventional charge for EOD = 3.2V

As expected, the EOD point significantly affects cell life using warp charge.

A modified algorithm will compensate for a deeply discharged scenario.

Summary

- *Our Warp Charge™ technology is very competitive in performance and price*
- *We can safely provide a 20% – 71% charge in 25 minutes*
- *Applicable for*
 - *batteries ranging from lithium ion 18650 cell to over 20,000Ahr batteries*
 - *lead based chemistries such as flooded, AGM, SLA and maintenance free*
 - *lithium cobalt oxide and lithium iron phosphate*
- *We can generate a customized solution per customer specifications*
- *Our Warp Charge™ technology....*
 - *can be an embeded or stand alone implementation*
 - *is aggressively priced and produces Superior Performance*
 - *is a reasonable tradeoff between charge speed and battery life!*

Contact: Lou Josephs

www.chargetek.com

Office: (866) 482-7930

Mobile: (805) 444-7792

NNP series NCR18650

Dimensions

(mm)

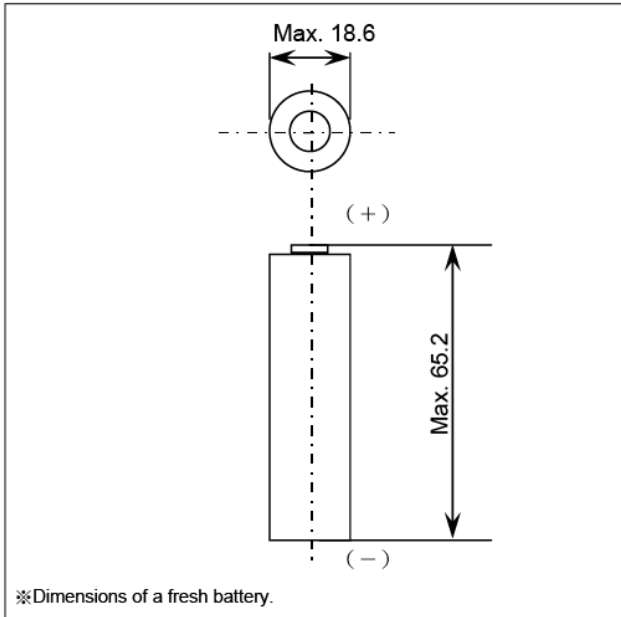

To ensure safety, the referenced Li-ion cell is not sold as a bare cell. Li-ion cells must be integrated with the appropriate safety circuitry via an authorized Panasonic Li-ion pack assembler.

Specifications

The data in this document are for descriptive purposes only and are not intended to make or imply any guarantee or warranty.

Nominal Voltage		3.6V
Nominal Capacity *1	Minimum	2,750 mAh
	Typical	2,900 mAh
Dimensions	Diameter	Max. 18.6 mm
	Height	Max. 65.2 mm
Approx. Weight		45 g

*1 Charge : constant voltage/constant current, 4.2V, max. 825mA, 50mA cut-off
Discharge : constant current, 550mA, 2.5V cut-off
Temperature : 25deg.C

Typical charge characteristics

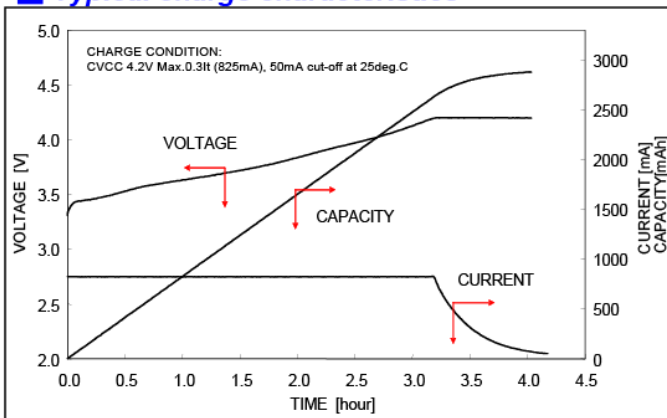

Typical discharge characteristics

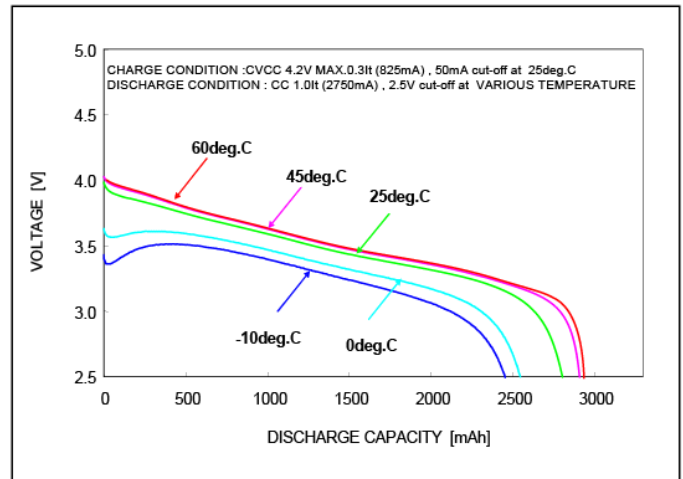
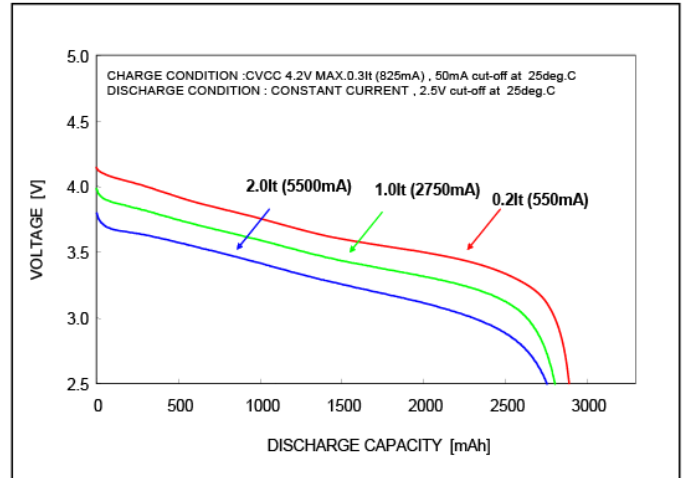

Typical life characteristics

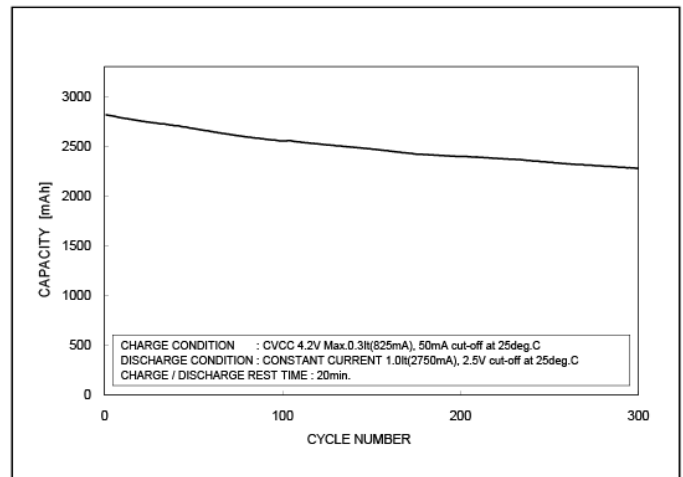

* CVCC: Constant Voltage Constant Current
CC: Constant Current